

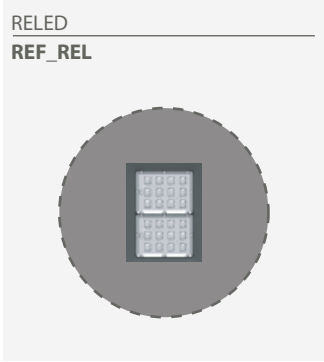

**RELED**

### FUNCTIONALITY OPTIONS



### LED CODE

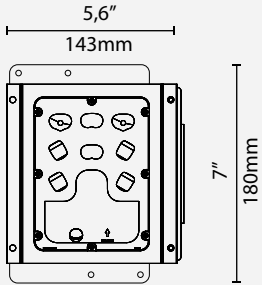

REF\_REL\_GF02

1,5 Kg  
2,2 lb

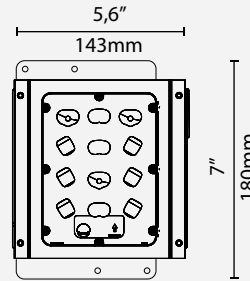

REF\_REL\_GF03

1,5 Kg  
2,2 lb

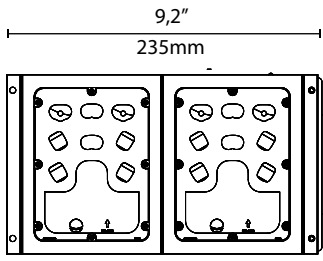

REF\_REL\_GF04

2,5 Kg  
5,5 lb

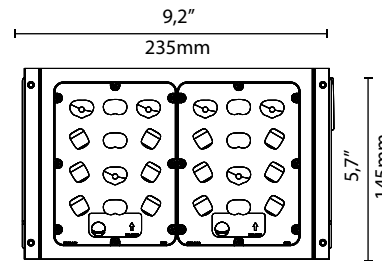

REF\_REL\_GF06

2,5 Kg  
5,5 lb

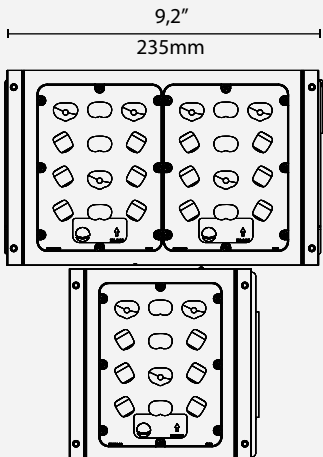

REF\_REL\_GF09

4,0 Kg  
8,8 lb

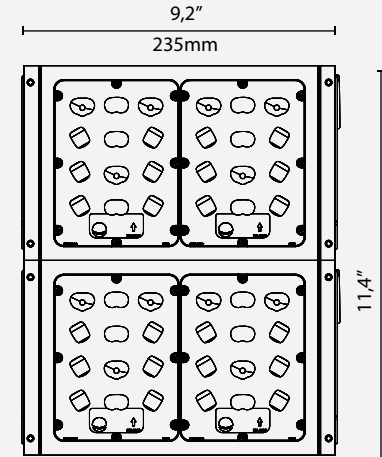

REF\_REL\_GF12

4,5 Kg  
9,9 lb

## Technical data

rev. 2022.02

Kit refitting for the lighting fixture LED conversion, made up of:

A. S235 sheet wiring plate galvanized with LED driver support function and other electronic devices;

B. Optical system components:  
 B1. The LED modules are fixed on an aluminium heat sink.  
 B2. IP66 and IK08 LED modules have PCB and PMMA optical cluster who gives a uniform light emission and it limits the glare effect, typical of LED sources (low-glare system), maximizing the visual comfort;

C. LED driver;

D. 0,5 m power cable.

ReLED is provided with S235 steel sheet mounting plate and gasket, galvanized and powder coated. The plate dimension, form and color are customized thanks to a feasibility study.

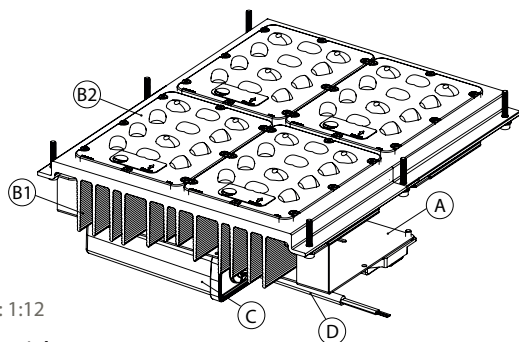

Scale: 1:12

### Max. weight

8,5Kg  
 fixing device excluded

### FIXING TYPE

#### Custom

The modules can be installed on customized plates designed by our technicians

### STANDARD

EN 60598-1, EN 60598-2-3, EN 62471, EN 55015, EN 61547, EN 61000-3-2, EN 61000-3-3

### CONFORMITY | PROTECTION

#### Conformity



#### Component to install



#### Photobiological safety



Classe 0 Exempt group IEC/TR62471

#### Insulation classes



#### Protection classes \*



(\*)  
 The Kit is IK09 after installation on the lighting body.

### PLUS



OPTICAL FLEXIBILITY



LOW GLARE



A++ IPEA MIN

### LIGHTING FIXTURE FEATURES

#### General features

Power source:	220-240V   50/60Hz   tolerance +/-10%
Current supply:	350 mA   525 mA   700 mA   1050 mA (P <sub>max</sub> = 152W)
Power Factor   THD:	≥0.95   <10 % (At full load)
Expected life (Ta=25°):	> 100.000 h   L90B10   @ LED 700mA
Operational temperature (Ta):	T <sub>min</sub> = -40°C   T <sub>max</sub> = +55°C   1000mA
Storage temperature:	-40°C/+80°C
Overcharge protection:	Main surge immunity up to 10kV
Disconnecter:	Disconnecter and cable clamp   cross section 1.5mm <sup>2</sup> ÷ 4mm <sup>2</sup>
Standard functions:	Current fixed   Virtual midnight   CLO

#### Materials

Lighting fixture:	Steel sheet
Optical system:	Optics in PMMA IK09
Gaskets:	Neoprene
Cable gland:	Polyamide PA66   PG16   Ø 14mm MAX   IP 66
Screws and bolts:	AISI 304 stainless steel
Fixture color:	Painted on request

### LED FEATURES

LED data 4.000 K - 700mA:	180 lm/W   25°C [Tj]   ≤ 3 step MacAdam
Color temperature:	3.000 K   4.000 K   5.700 K   CRI ≥ 70

### OPTIONAL

	Fixed current	Virtual midnight	CLO	DALI 1   DALI 2 **	DALI SENSOR **	Lumawise socket Zhaga 4PIN	Nema Socket 7PIN	SPD CLASS1   CLASS 2	IP66 box	2-3   4-5 core connector	Remote control Standard   GPS
REF_REL	✓	✓	✓					✓		✓	

(\*\*)For the additional functions in the table refer to the Reled Plus datasheet

### ASYMMETRICAL DISTRIBUTION\\

1A

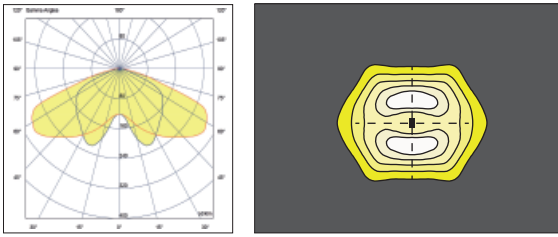

TYPE 1A

### ASYMMETRICAL DISTRIBUTION\\

2A

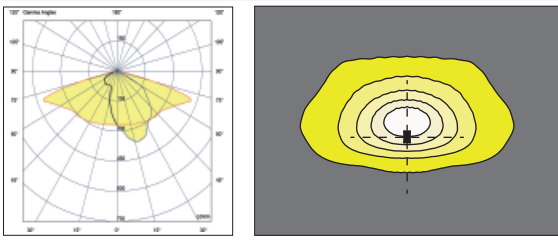

TYPE 2A

### ASYMMETRICAL DISTRIBUTION\\

3A

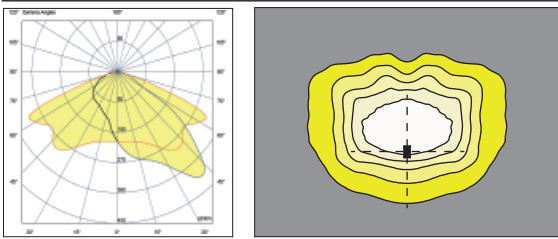

TYPE 2A



TYPE 3A | TYPE 3B

3B

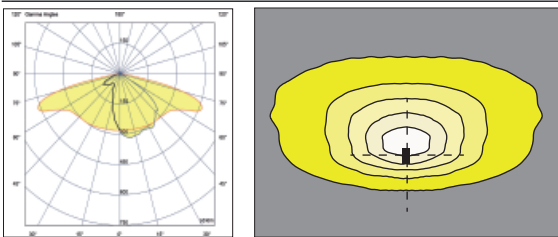

TYPE 5A

3C

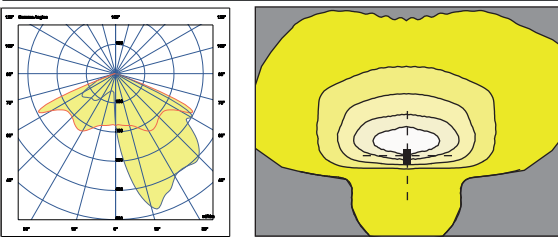

### ASYMMETRICAL DISTRIBUTION\\

5A

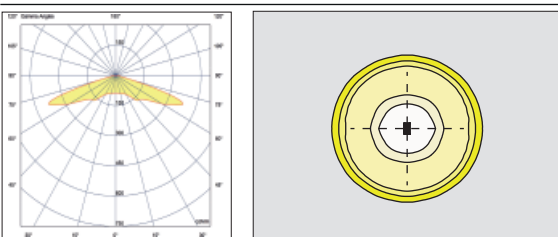



The LED modules nominal data refers only to the LED light sources in a standard version, with 4000 K color temperature, color rendering index CRI 70 min. and a junction temperature  $t_j$  of 25°C. The LED nominal data are extrapolated from the manufacturer documentations.

LED code		(•) I [mA]	Luminous flux [lm]	LED Power [W]	Efficiency [lm/W]
GF02		350	1759	9,4	188
		525	2510	12,8	197
		700	3192	16,6	193
		1050	4463	25,7	174
GF03		350	2588	11,9	217
		525	3693	17,8	207
		700	4696	23,9	196
		1050	6622	38,3	173
GF04		350	3450	15,7	219
		525	4842	23,9	202
		700	6144	32,5	189
		1050	8309	49,5	168
GF06		350	5127	23,9	214
		525	7277	36,9	197
		700	9146	49,5	185
		1050	12490	75,1	166
GF09		350	7548	36,9	205
		525	10710	55,1	195
		700	13455	73,3	184
		1050	18362	111,8	164
GF12		350	9969	48,2	207
		525	14143	71,9	197
		700	17587	97,1	181
		1050	24202	139,4	174

The lighting fixture measured data refers to GMR ENLIGHTS products in a standard version, with 4000 K color temperature, optica type 3B and an ambient temperature  $t_a$  of 25 °C.

**GMR ENLIGHTS offers the possibility of driving the device with custom currents (•).**

In case of optional glass some LED codes may be different from those indicated (GL02, GL04, GL06). In this case the values of luminous flux and efficiency are different from those shown in the table.

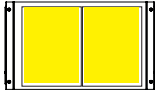
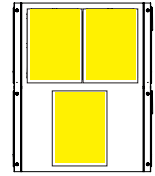
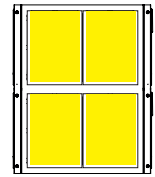
Order code: REF_REL_GFxx	(•) I [mA]	Luminous flux [lm]	LED Power [W]	Efficiency [lm/W]
GF02 	350	1548	11,0	141
	525	2209	15,0	147
	700	2809	19,5	144
	1050	3927	29,5	133
GF03 	350	2277	14,0	163
	525	3250	20,5	159
	700	4133	27,5	150
	1050	5827	42,5	137
GF04 	350	3036	18,5	164
	525	4261	27,5	155
	700	5407	36,5	148
	1050	7312	55,0	133
GF06 	350	4512	27,5	164
	525	6404	41,0	156
	700	8049	55,0	146
	1050	10991	82,5	133
GF09 	350	6642	41,0	162
	525	9425	60,5	156
	700	11840	80,5	147
	1050	16158	121,5	133
GF12 	350	8772	53,5	164
	525	12446	79,0	158
	700	15477	105,5	147
	1050	21298	151,5	141

### OPTIC CONVERSION FACTOR LUMINOUS FLUX

Optic type	Flux multiplier
1A (*)	1,00
2A (*)	0,99
3A	0,97
5A (*)	1,01

### Tk CONVERSION FACTOR LUMINOUS FLUX

Tk [K]	Flux multiplier
2.200 (**)	0,70
3.000	0,95
4.000	1,00
5.700	1,01

### CRI CONVERSION FACTOR LUMINOUS FLUX

CRI (color render index)	Flux multiplier
70	1,00
80	0,95

(\*\*) See pag: Technical data, to check the colour temperature availability.

# Functions

## Standard functionality

### Fixed current

During production, the light fixture is pre-set with a fixed current amongst the standard settings that appear in the tables on page 3. Upon customer's request, it is also possible to set a specific current (custom setting).

### Virtual Midnight | Automatic dimming

The driver is programmed to automatically dim the light output according to the time. As required by regulations, the maximum output is set during initial hours and towards the end of the light fixture's operating time interval. During these hours there is statistically more traffic. The light output is then dimmed during the central hours of the operating time interval. This management is achievable through a self-learning process of the device, that establishes the centre point of the time interval. This moment is called "virtual midnight" and is the point that the dimming profile refers to in order to know when to reduce the light output. We can manage up to 8hrs of programming that evolve around the virtual midnight and up to 5 steps of dimming. This way the light output will adjust automatically, adapting throughout the year to the duration of the nighttime, by referring to the pre-set parameters based on the centre point of the operating time interval.

### CLO Constant Lumen Output

LEDs over time are inevitably subject to performance depreciation. This light reduction may be compensated by gradually increasing the LED's current during its lifespan, this corresponds to a gradual increase of lumen output proportional to the amount that is naturally depreciated.

## On request functionality

### DALI - DALI2 Control and monitoring system

On request, the fixture can be fitted with a DALI2 communication interface. This protocol allows it to be monitored and controlled remotely through use of Dali control buses.

### DALI SENSOR (D4i)

On request, the fixture can be equipped with a D4i certified power supply. This is the ideal solution for wireless sensors and/or controls. This system was developed to integrate various systems to address smart city requirements. Included is DALI2 protocol + auxiliary power (AUX) to supply power to devices and sensors. This system is usually required when using a Zhaga Lumawise socket.

### LINESWITCH

This functionality by using an extra wire within the streetlight's power line, allows to dimmer to a pre-set level. For example, a centralised timer can change this value from 100% to 50%, and vice versa.

### AMPDIM

This feature allows dimming using the power line controlled by an upstream flow regulator. For this feature, the flow controller must use amplitude modulation (AM).

### NEMA | Nema Socket (7 PIN)

The Nema Socket is a 7 PIN connector/socket with IP66 rating, that is fitted on the fixture to make it interfaceable with various ANSI C136 compliant devices and remote-control gear. These devices can be installed during or after installation of the light fixtures. The NEMA socket can provide power interruption and is interfaceable with DALI buses and/or 1-10V dimming. It is compatible with point-to-point node connection, and twilight sensors ect.

### ZHAGA Lumawise Zhaga Socket (4 PIN)

The Lumawise Zhaga socket is a small and compact 4 Pin connector/socket, that is fits ideally with the design of GMR ENLIGHTS fixtures. With ZHAGA Lumawise sockets it is possible install the devices, sensors, ZHAGA remote controls during or after installation of the light fixtures. This socket is usually required in conjunction with the DALI Sensor feature, which involves a DALI2/D4i communication protocol in addition to 12/24V auxiliary port to supply power to the sensors. It is compatible with point-to-point wireless control solutions and SMART CITY applications to control and monitor the public lighting infrastructure.

### REMOTE CONTROL ZHAGA STD

The device is installed on the lighting body equipped with D4i driver, via a prepared zhaga socket. The remote control works at 2.4GHz frequencies, and communicates in a secure mesh network thanks to 256bit data encryption. Thanks to the better positioning of the antenna, the node allows you to cover large distances and overcome obstacles. Equipped with lux meter and accelerometer, it can work both stand-alone and within the dedicated communication infrastructure. The device implements energy saving policies that bring the average consumption to 0.19W. In the smartcity application, the node allows you to interact with the street lighting network, dimming the lighting fixtures as needed and based on traffic and weather conditions, bringing significant economic advantages to the system in terms of energy savings. The node also allows monitoring and diagnostics of the public lighting network, from a single area, to the country up to an entire city or region. The knot has a diameter of 80mm and a height of 59mm. IK09, IP66.

### ZHAGA GPS REMOTE CONTROL

In addition to the functionality expressed for the STD version, this version also includes a GPS. Thanks to GPS, the system can count on an astronomical clock as well as all the functions related to the exact positioning of the lighting body. Especially in the installation and commissioning phase, having the information relating to the positioning available simplifies and significantly speeds up the start-up of the system.

### PRESENCE SENSOR

The product can be equipped with a presence sensor type zhaga book 18 in the lower part of the luminaire. In this case the lighting body is provided with Zhaga socket and Driver D4i. It is very important to carefully evaluate the installation context (height and underlying area) according to the sensing diagram of the device.

### Third-party remote control

GMR ENLIGHTS fixtures are compatible with most third-party remote controls, powerline communication systems, wired systems (buses) and wireless systems.

Example of 4-step adjustment with virtual midnight

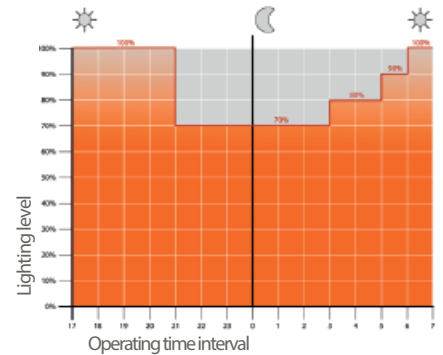

CLO Light Flow Compensation

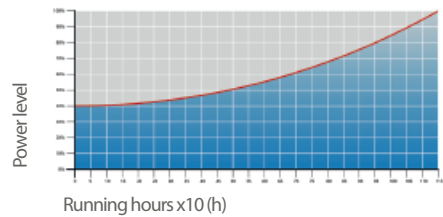

7 Pin Nema Socket 7 (A) and IP66 shorting cap (B)

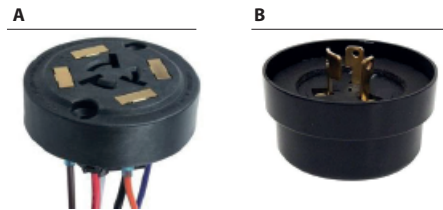

4 Pin Lumawise Zhaga Socket (C) and IP66 cap (D)

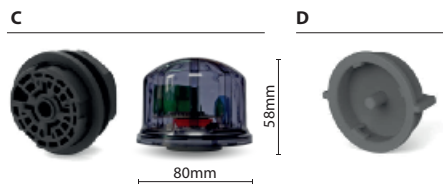

Installation example of Lumawise Zhaga



Installation example of presence sensor

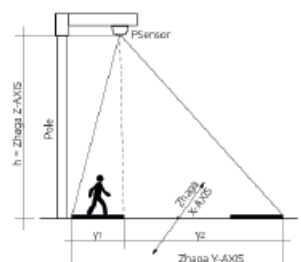



## Protection cycles

GMR ENLIGHTS works with cast iron, steel and aluminum. The materials are selected and processed to maximize performance and quality.

### GALVANIZED STEEL

#### Protection of galvanized steel surfaces for poles

The protection of galvanized steel elements is achieved by following steps:

- Micro sandblasting;
- First epoxy layer application followed by: Wilting > Drying > Cooling;
- Acrylic glaze layer application followed by: Wilting > Drying > Cooling;
- Packing at least after 24-hour-drying at room temperature.

#### Protection of galvanized steel surfaces for brackets and pastorals

The protection of the galvanized steel elements is achieved thanks to:

- Micro sandblasting;
- Phosphoric pickling bath at a ph level ranging from 1.5 to 3;
- Rinsing with demineralised water;
- First powder layer application;
- Kiln firing;
- Application of a final powder layer;
- Kiln roasting of the final powder layer at 180°C (356°F);
- Cooling.

### CAST IRON

#### Protection of cast iron surfaces for bases

The protection of cast iron elements is achieved by the following treatments:

- Surface micro shotblasting;
- Mono-component dip galvanizing followed by: Wilting > Drying > Cooling;
- Epoxy micaceous primer application followed by: Wilting > Drying > Cooling;
- Acrylic enamel application followed by: Wilting > Drying > Cooling;
- Packing at least after 24-hour-drying at room temperature.

### DIE-CAST ALUMINIUM

#### Protection of die-cast aluminium surfaces for lighting fixtures, tops, collars, brackets and pastorals

Lighting fixtures, brackets, pastoral, and die-cast accessories undergo a cycle of powder painting which creates a barrier against the corrosion of metal parts. Moreover this barrier makes the finished product comply with design specifications in terms of surface roughness, color and reflectance.

The cycle consists of the following steps:

- Micro sandblasting;
- Hot pickling bath in a zinc-based phosphodegreasing solution;
- Specific process for the preparation of surfaces before painting;
- Washing with water;
- Rinsing with demineralised water and subsequent drying;
- First powder layer application followed by kiln baking at 180°C (356°F);
- Final powder layer application using a High Durability product and final kiln roasting at 180°C (356°F).



#### Salt spray test

The top quality of such treatments is confirmed by salt spray tests performed in accordance with standard ISO 9227:2017 Neutral Salt Spray test (NSS).

The test was carried out for 8.000 hours at 35°C (95°F) and demonstrated through the report test released.



**GMR ENLIGHTS s.r.l.**

Legal headquarters:  
Strada Provinciale Specchia - Alessano, 68 • 73040 (LE)

Administrative and operational headquarters:  
Via Grande n°226 • 47032 Bertinoro (FC)

T +39 0543 462611  
F +39 0543 449111

[sales@gmrenlights.com](mailto:sales@gmrenlights.com)  
[www.gmrenlights.com](http://www.gmrenlights.com)