



SYRIUS

THE NEXT GENERATION
IN LIGHTING

Innovative Optical Waveguide Platform

CREE  LIGHTING 

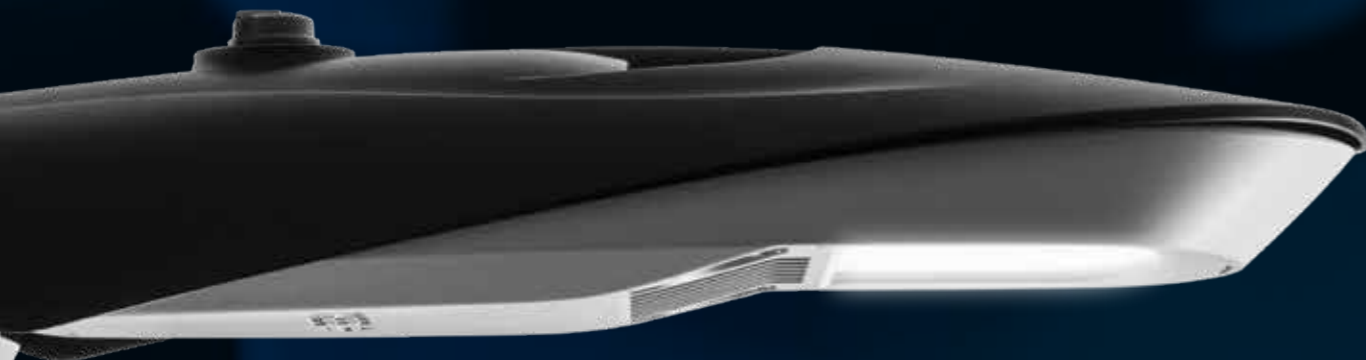

Driving under SYRIUS,
unprecedented **comfort.**





Designed for people who live under it.

MAXIMUM VISUAL COMFORT



UNIFORMITY



COMFORT IN URBAN AREAS

Syrius is designed for urban areas and city dwellers.

This totally unique approach makes light an element that accompanies the end of the day and, particular, the creation of **“human-centric” lighting**.

Glare control is today the real challenge for anyone whose mission is not only the product's efficiency, but also and, above all, the well-being and health of city-dwellers.

The Next Generation in Lighting

ITALIAN STYLE

Syrius has been designed to provide a new approach to traditional city lighting application; no matter which context the fixture needs to be installed in it has to be sympathetic to the environment; **Light a Better Way.**

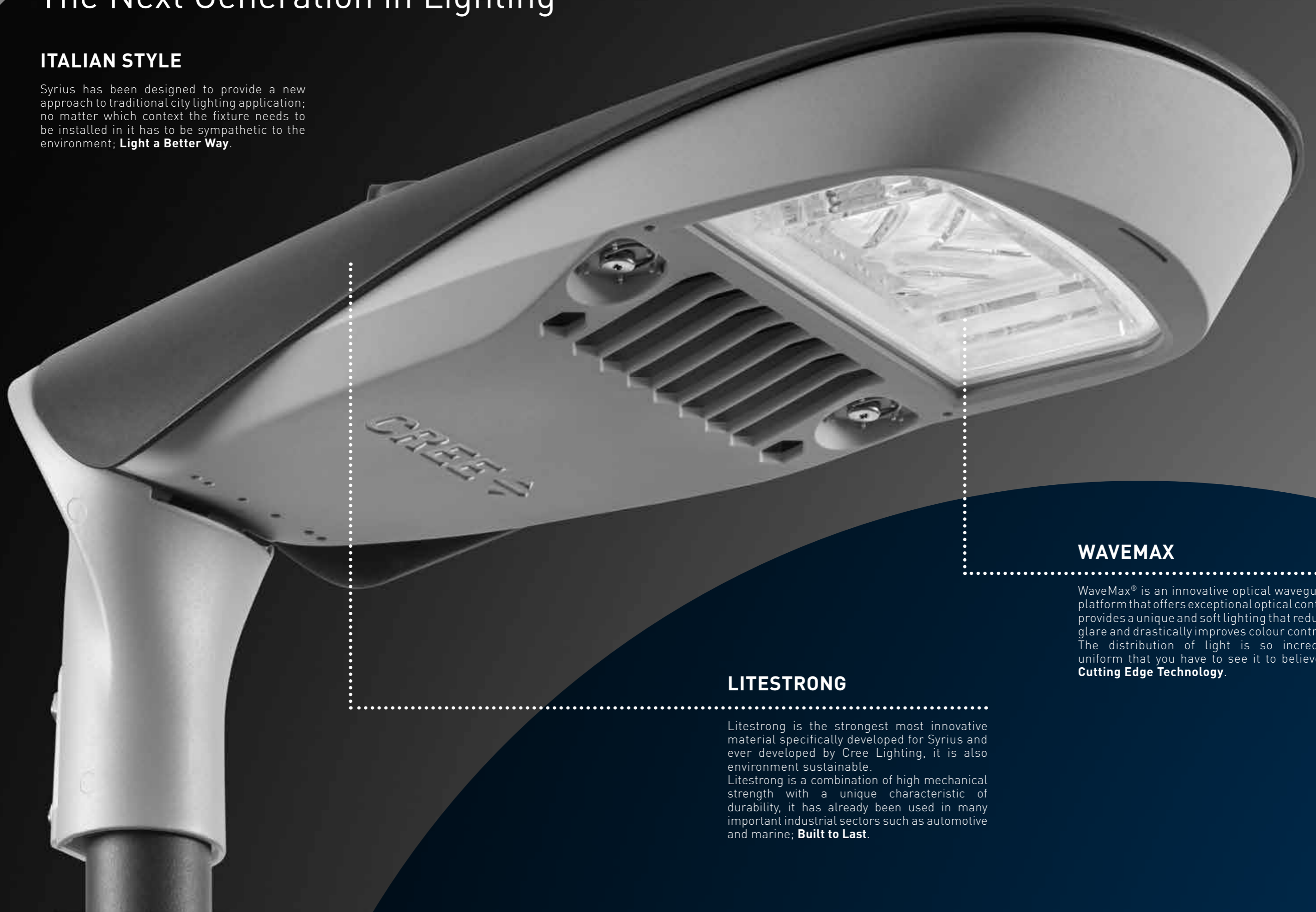

WAVEMAX

WaveMax® is an innovative optical waveguide platform that offers exceptional optical control, provides a unique and soft lighting that reduces glare and drastically improves colour contrast. The distribution of light is so incredibly uniform that you have to see it to believe it; **Cutting Edge Technology.**

LITESTRONG

Litestrong is the strongest most innovative material specifically developed for Sirius and ever developed by Cree Lighting, it is also environment sustainable. Litestrong is a combination of high mechanical strength with a unique characteristic of durability, it has already been used in many important industrial sectors such as automotive and marine; **Built to Last.**

WAVEMAX® TECHNOLOGY

FROM THE COMPANY THAT CHANGED THE WAY IN WHICH THE WORLD APPROACHES LIGHT, OUR SMARTEST LIGHT EVER.

Traditionally, the design of light fixtures have been strongly influenced by the technology used inside them, LED lighting promised to change this trend, but up until now the appearance of products has not substantially changed because the efforts to break the linear relationship between a light source and the product itself have resulted disappointing. With the introduction of **WaveMax® technology**, Cree Lighting ushers in a new era of LED lighting using this innovative optical waveguide platform. The optical fixtures offer a much higher quality compared to the products used on the market until now, mainly through a few basic aspects which **benefit the human eye**:

- Removing direct emission which is the main cause of discomfort glare on the human eye.

- Less brightness contrast in the emitting surface between the areas of light and shadow which is one of the major aspects of visual discomfort.
- Reducing pixellation effect, a negative phenomenon for the human eye.
- Improving colour consistency and distribution of the light.

The attention to details of all aspects of the "Syrius" project make it a major milestone for Cree Lighting by creating a sustainable product with cutting-edge technology, redefining the limits of lighting fixture design, optimizing performance and providing a broader range of aesthetic options.



Comfort & Appeal



Efficiency



Uniformity



Control



WAVEMAX® TECHNOLOGY

CUTTING EDGE TECHNOLOGY

With the introduction of Sirius, Cree Lighting changes the way in which the world looks at lighting and light itself.

WaveMax®, an optical waveguide, acts to channel and guide light waves from, for instance, Point A to Point B, and crucially, to keep them confined while conveying them.

A fiber optic strand is a common example of a wave guide. Shine a light at one end, and thanks to a property called **Total Internal Reflection (TIR)**, the light appears at the other end of the strand with very little light lost along its length.

This is true for any waveguide of the proper geometries.

Additionally, WaveMax® ensures that the light is released and controlled properly, in fact the Cree Lighting engineers have created **Diamond Facet™** optical elements, whose unique microscopic characteristics, located inside the optical waveguide platform, extract and distribute a uniform, comfortable light with **exceptional efficiency**.

By using optical elements **WaveMax® Technology** offers exceptional optical control, thus

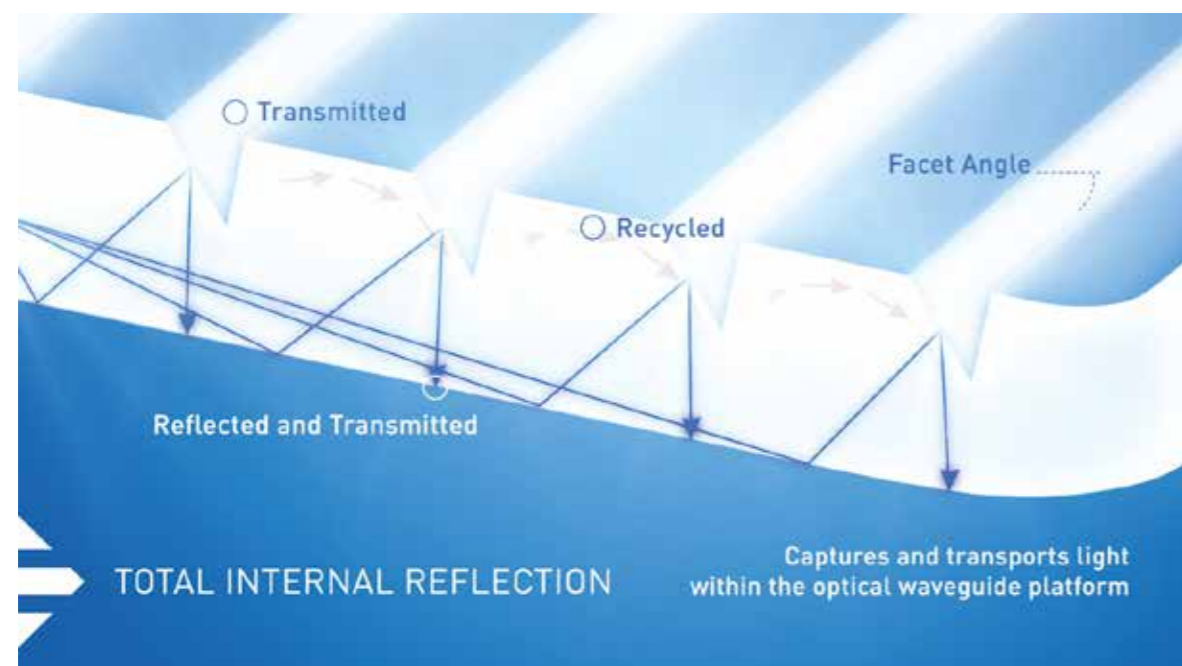

guaranteeing that the **light is soft and pleasant and delivered with maximum precision**.

This unique approach makes light a crucial element that accompanies the end of the day reducing the stress perceived when our gaze is

annoyed by the LEDs' brightness. These advances in optical technology make it possible to obtain a more comfortable environment for people and social settings.

MAXIMUM COMFORT

LED lighting is now synonymous with energy saving which makes it an obvious choice in both projects to make old systems more efficient and in the design of new systems. People, however, increasingly complain about new LED street lighting due to brightness of the LEDs exposed directly to the human eye. To respond to this critical issue Cree Lighting changes the perspective with which the product is conceived. The product is no longer recognized as simply a source of light and energy savings, but rather as a tool to improve the comfort and, therefore, **the quality of life of city dwellers**; thus the urban setting should be thought in the same way as we think our garden or even our home, so that it can be appreciated and enjoyed in total comfort.

WaveMax® technology provides a unique, soft lighting that reduces glare and drastically improves colour contrast. **Sirius is approved by International Dark Sky Association.**



TRADITIONAL OPTICS

SYRIUS

VISUAL COMFORT

One of the elements which has the greatest impact on visual comfort is the chromatic uniformity of the surface that delivers the light. Traditional LED technology, even though the LEDs

are surrounded by optics, is visible to the human eye which can perceive the colour difference caused by the typical selection of diodes known as BINNING.

SYRIUS



TRADITIONAL OPTICS

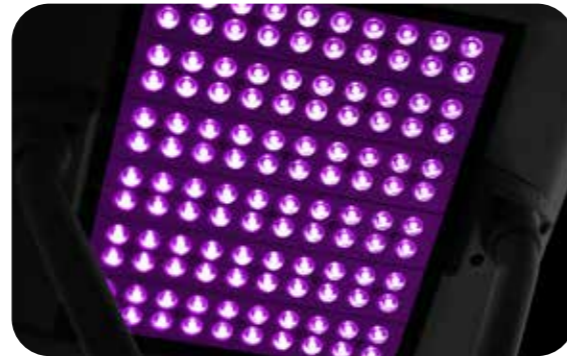

WaveMax® technology has solved the root of the problem by removing the LEDs from the field of vision and having as a result low glare levels which, together with the ideal levels of luminosity and superior colour quality, guarantee uniform light and creates installations with a visually and aesthetically superior level of comfort.

The total absence of direct luminance ensures an unprecedented and perceptible result, in terms of visual comfort and ability to relax the eye, for all users (drivers and pedestrians), eliminating the annoying problem of glare that currently plagues our roads.

COLOUR CONSISTENCY

If we compare the Syrius optical system with "direct" traditional optics, the distribution of the light emitted is so accurate and optimised that there is almost total uniformity on the ground and the colour consistency is significantly improved.

The WaveMax® optic ensures a result in which we see objects with their **real colours** and observe them better without causing visual stress to our eyes.

SYRIUS

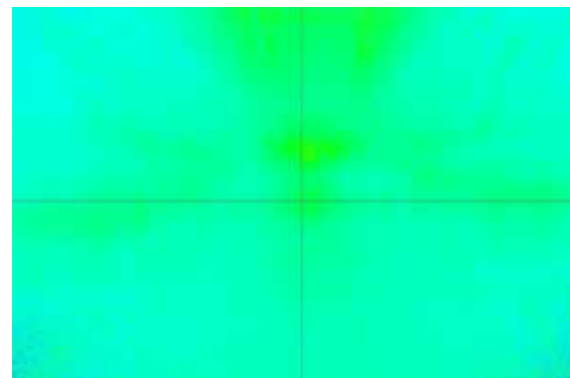

TRADITIONAL OPTICS

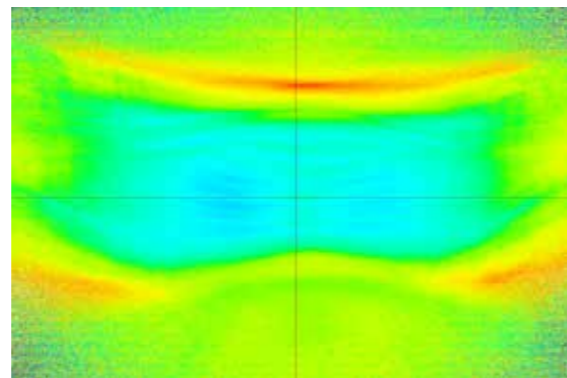

PIXELLATION

Contrast sensitivity is the ability to notice the slightest variation in light intensity (luminance) between two objects or areas adjacent to the surroundings, and it is essential to distinguish objects from the background and understand where one begins and the other ends. The WaveMax® optical system makes it possible to **reduce the effect of pixellation** a negative phenomenon for the human eye.

This principle is based on the reduction of overlapping shadows between different sources, making the images clearer, removing the distortion of the illuminated objects and returning a more real, authentic and comfortable image to the human eye.

SYRIUS

A NEW ERA IN LIGHTING,
REMOVING LEDS FROM SIGHT!

TRADITIONAL OPTICAL TECHNOLOGY

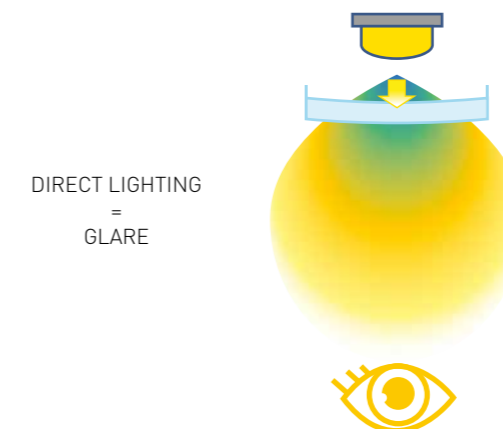

WAVEMAX® TECHNOLOGY

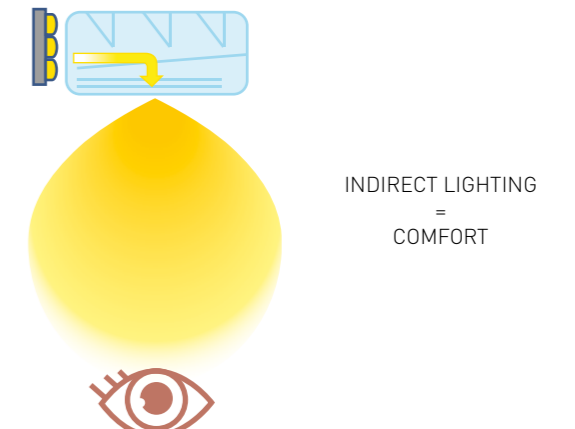

TRADITIONAL OPTICS

SYRIUS



IK 10

LITESTRONG

Cree Lighting has always endeavoured to respect the highest standards in terms of quality and environmental performance and thus, guarantee the highest levels of excellence for its products. Indeed, thinking about a sustainable product means looking at the impact it has on people and the environment from all sides. Accordingly, we have developed for Sirius a totally **innovative material**; In fact, metal replacement is a practice already in use for several years in various industrial sectors such as marine or automotive (i.e.: structural part of motorbike usually produced in steel or aluminum), and specifically, in the motorbike race (MotoGP, Dakar Rally) where high performance is required in terms of durability, mechanical strength and constant lightening of materials. The result is **Litestrong**, a combination of technopolymers, specifically developed by Cree Lighting's Research and Development department and capable of guaranteeing unique results. The Litestrong production process requires 68% less energy compared to a similar product made of die-cast aluminium of the same weight. It consumes

94% less water and reduces its overall ecological footprint by 67%. The result is a product with a material density that it is 41% lower, that weighs less and is easier to handle which is an undisputed advantage during installation.

There is also **no pollution** from fine dust particles or from the disposal of paints or similar, plus less pollution from painting systems because the colour of the product is created during the production process itself and does not require a second phase of surface finishing. Litestrong is recyclable, intrinsically lighter and, therefore, has a lower environmental impact with the transportation of materials.

Despite all the advantages in terms of **environmental sustainability**, Litestrong is the strongest material ever produced by Cree Lighting, featuring unique characteristics of **durability** to atmospheric agents, corrosion and mechanical resistance. Moreover, the thermal management means it is ideal for the most severe environmental temperatures without alternating its characteristics.

SUSTAINABILITY

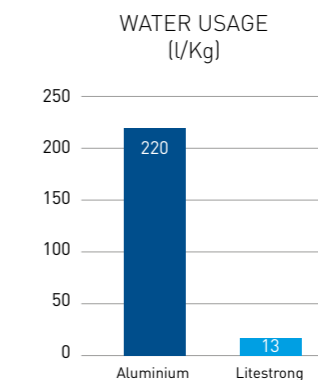
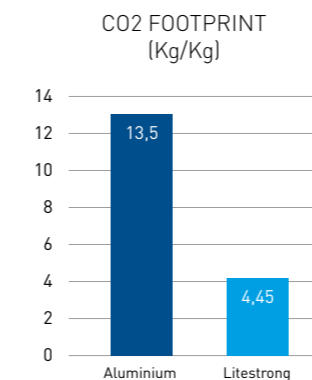
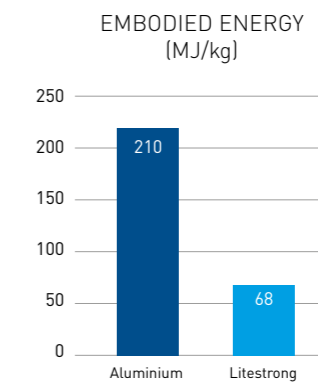
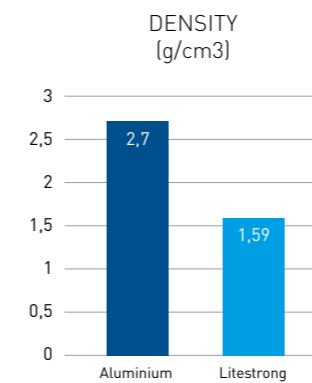

COOL FLOW

Thermal COOL FLOW system is based on an airflow management technique that improves the LEDs performance. This breaks new ground and extends the product's useful life, making it considerably longer than market standards.

INDIRECT LIGHT

Indirect LED source helps create a smooth distribution of light and reduces perceived glare.

WAVEMAX® TECHNOLOGY

Innovative optical elements capture and distribute light precisely where it is needed while dramatically reducing glare.

LITESTRONG

Innovative advanced technology material providing exceptional strength to weight ratio, good thermal characteristics and exemplary sustainability. Increasingly adopted in hi-tech and environmentally aware applications such as motorcycle racing, marine engines etc. The strongest material ever produced for Cree Lighting with a class leading **impact rating of IK10.**

DESIGNED TENON

Perfectly integrated to product design.

SUSTAINABILITY

Litestrong is recyclable with the highest material circularity indicators.

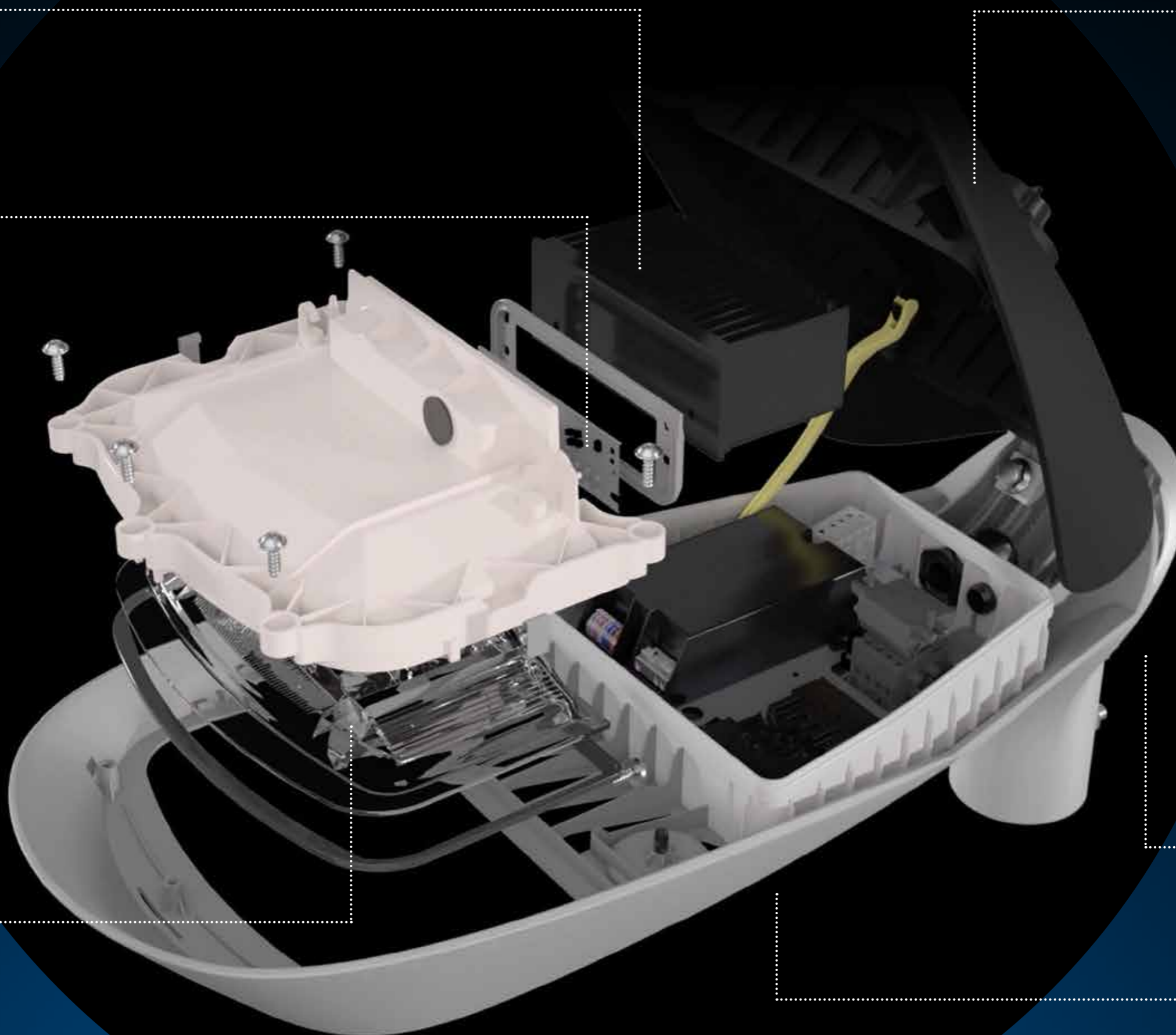

SYRIUS

DESIGN MADE IN ITALY

THE NEXT GENERATION IN LIGHTING

A new star is born in the Cree Lighting offer; a new slim-line, sophisticated shape defines its profile; Bright and slimline, **Syrius brings brightness and safety to city streets**, allowing residents to regain their urban space and to **enjoy their city by night**.

From the optical design, down to the smallest detail Syrius has been designed specifically for urban areas and residential road systems. Regardless of the setting, each installation must be discreet during the day without compromising the identity of the neighbourhood whilst providing safety and comfort to residents and drivers during the night.

The concept behind Syrius is to offer a new sustainable approach to city lighting, with a revolutionary optical technology WaveMax®, which gives an **unprecedented visual comfort**.



DESIGNED FOR URBAN AREAS AND CITY DWELLERS

In some settings, the finish of a device can be just as important as its performance. With Syrius, playing with the colours makes it possible to completely change its aspect, either blending in to pass unnoticed or standing out to add character.

COLOURS REFERENCE



SYRIUS - LED street lighting fixture

Product description

Syrius, the first street luminaire with WaveMax® technology which will transform the way cities are illuminated.

Syrius is the first lighting fixture with indirect LED lighting with CCT 2700 and efficiency values up to 130 lm/W. It offers greater visual comfort, reduced glare and a high colour contrast resulting in an overall improvement in lighting without losing sight of the goal of saving energy. Syrius is a **Dark Sky approved** product for respect for light pollution.

Applications: Residential streets, parking lots, urban areas.

Performance summary

Uses Cree WaveMax® Technology

Efficiency: Up to 130 lm/W

Initial Colour consistency: 4 MacAdam steps

Warranty: Class 1 - 10 years on lighting fixtures
Class 2 - 5 years on lighting fixtures



Ordering information

E.g. SYS-A-02-2SH-A-278--24-SVS-AOC-S-00+FDL09AA0-0007

SYS	A	02	2SH	A	278	+	24	SVS	AOC	S	00
Product	Version	Mounting	Optic	Input Power	CCT	Insulation Class	Voltage	Finish	Options	Variant	Cable length
SYS	A	02 horiz/vert tenon 60mm OD	210 Type II short 1,0	A	278 2700K CRI80	+	24 220-240V	SVS Silver/ Silver	AOC Fixed Output	S	00 Standard (w/o cable)
		03 horiz/vert tenon 76mm OD	2SH Type II short		307 3000K 70CRI	^		BKB Black/ Black	DIM Dimmable 1-10V	SF	01 Exit cable 30cm
					308 3000K 80CRI			SVB Silver/ Black	DL DALI Dimmable	N	03 Exit cable 3m
					407 4000K 70CRI			BKS Black/ Silver	G* Lineswitch	NF	06 Exit cable 6m
					408 4000K CRI80			WHW White/ White	RF* Flux regulator	NF	10 Exit cable 10m
	B								SR** Sensor Ready	Z** Zhaga	
									VMS** Virtual Midnight Full	ZF** Zhaga+ Fuse	
									AOC Fixed Output	S	
									DIM 1-10V Dimmable	SF	
									VML Virtual midnight Lite	N	
										NF	

* These options are available only with the S and SF variations
** These options are available only with version A

TECHNICAL FEATURES

- Uses Cree WaveMax® Technology
- Lumen output: 620 – 5000 lm
- System efficiency: up to 130 lm/W
- CCT: 2700K@CRI80, 3000K@CRI70, 3000K@CRI80, 4000K@CRI70, 4000K@CRI80
- Initial CCT LED selection: 4 MacAdam steps
- Voltage input: 220-240V 50/60Hz
- Driver fitted with overtemperature protection to guarantee optimal performance and safety
- Power factor: up to > 0.98 at full load
- Duration: L90F10 up to 205Khrs Ta=25° (According to IEC/EN62717 and IESNA TM-21)
- Surge protection: 10kV CM/DM according to EN 61000-4-5 and EN 61547 (Class I SPD with LED Signal)
- IP66 (IEC 60529) / IK10
- Working temperature: -40°C up to +50°C (with decrease in lumen output)
- Insulation class: Class I - Class II
- H07RN-F cable (length of cable up to 10 m)
- Fuse option available
- Control options: ADJ. Output Current, DALI, Virtual Midnight (plus switch-off function) Flux Regulator, Lineswitch, Sensor Ready
- Nema socket option available
- Zhaga socket (Book 18) option available
- Power supply housing accessible without the use of tools
- Removable power supply unit
- LED board with built-in surge protection.
- Lighting fixture assembled without the use of adhesives which can be fully dismantled and recycled.

CONSTRUCTION AND MATERIALS

- The lighting fixture is made of LiteStrong, an innovative composite material which allows up to 98% of the materials to be recycled.
- COOL FLOW innovative heat dissipation system
- Litestrong is resistant to corrosion and does not require the saline mist test.
- The die-cast aluminium pole-top with <0.1% copper content, featuring the exclusive Colorfast DeltaGuard finish, an epoxy e-coat with ultra-resistant powder external surface, which guarantees excellent resistance to corrosion and deterioration from ultraviolet and abrasion.
- The other materials exposed are all corrosion resistant.
- The lighting fixture is designed to be assembled on a pole or assembly support with an external diameter of 60 mm or 76 mm, with an adjustment tolerance of +/-20° in 5° steps.
- Fitter 02 for installation on horizontal/vertical supports Ø60 mm, fitter 03 Ø76 mm.

WARRANTY AND CERTIFICATIONS

- Warranty: Class 1 - 10 years on lighting fixtures
- Warranty: Class 2 - 5 years on lighting fixtures
- CE Mark / CB Mark / ENEC Mark / RoHs compliant / RCM Mark
- Meets CAM requirements
- Risk class exempt in accordance with the IEC EN 62471 standard for photobiological safety (IEC/TR62778 tested)
- Compliant with the EN 60598-1; EN 60598-2-3 standards

ELECTRICAL DATA*

Power indicator	System power 220-240V	Total current	Power Factor
		@230V, 50Hz	
A	40	0,177 A	0,98

* Electrical data at 25°C (77°F)

WEIGHT AND MAXIMUM SURFACE EXPOSED TO THE WIND

WEIGHT	Side surface exposed to the wind
6,5 kg	0.058m²

LMF – LUMEN MAINTENANCE FACTOR RECOMMENDED BY CREE¹

Area	Power indicator	Initial LMF	25K hr LMF projected ²	50K hr LMF projected ²	75K hr LMF calculated ³	100K hr LMF calculated ³
+25°C	A	1	0,99	0,97	0,96	0,95

¹ Lumen maintenance values calculated at 25° C, with TM-21 on the basis of LM-80 data and on-site tests on the lighting fixture.
² In compliance with IESNA TM-21-11, the values indicated in the "projected" column represent interpolated values relative to time spans within six times (6X) the total duration in hours of the tests (carried out according to IESNA LM-80-08) to which the device (DUT) e.g. the LED chip) was subjected.
³ In accordance with IESNA TM-21-11, the values indicated in the "calculated" column are calculated based on a time span six times (6X) greater than the total duration in hours of the tests (carried out according to IESNA LM-80-08) to which the device (DUT), e.g. the LED chip) was subjected.

NEMA OPTIONS AVAILABLE

Option	Description	Control
AOC-N	Nema 7 pin with AOC	(on-off)
DIM-N*	Nema 7 pin with DIM cables	(on-off + Dim)
VML-N	Nema 7 pin with VM	(on-off)
DL-N*	Nema 7 pin with DALI	(on-off + Dim)
AOC-NF	Nema 7 pin/Fuse with AOC	(on-off)
DIM-NF*	Nema 7 pin/Fuse with Dimmable cables	(on-off + Dim)
VML-NF	Nema 7 pin/Fuse with VM	(on-off)
DL-NF*	Nema 7 pin/Fuse with DALI	(on-off + Dim)

- on-off: Nema allows for on-off control only
- on-off + Dim: Nema allows for on-off and dimming control
* Cables DIM (1-10V and DALI) are connected to the NEMA socket

ZHAGA OPTIONS AVAILABLE

VMS - ZF	Sensor Ready with VM and Fuse
SR - Z	Sensor Ready with Zhaga
VMS - Z	Sensor Ready with VM
SR - ZF	Sensor Ready with

Accessories available

ADAPTORS

KIT-XSP-AP60-34-G0
Adaptor for assembly on 34 mm supports

KIT-XSP-AP60-42-G0
Adaptor for assembly on 42 mm supports

KIT-XSP-AP60-48-G0
Adaptor for assembly on 48 mm supports

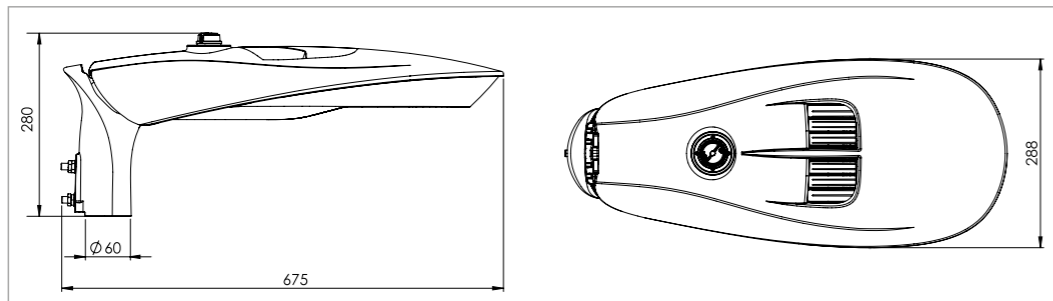

CREE  **LIGHTING**

A COMPANY OF *IDEAL INDUSTRIES, INC.*

info.europe@cree.com